

MaxMotion

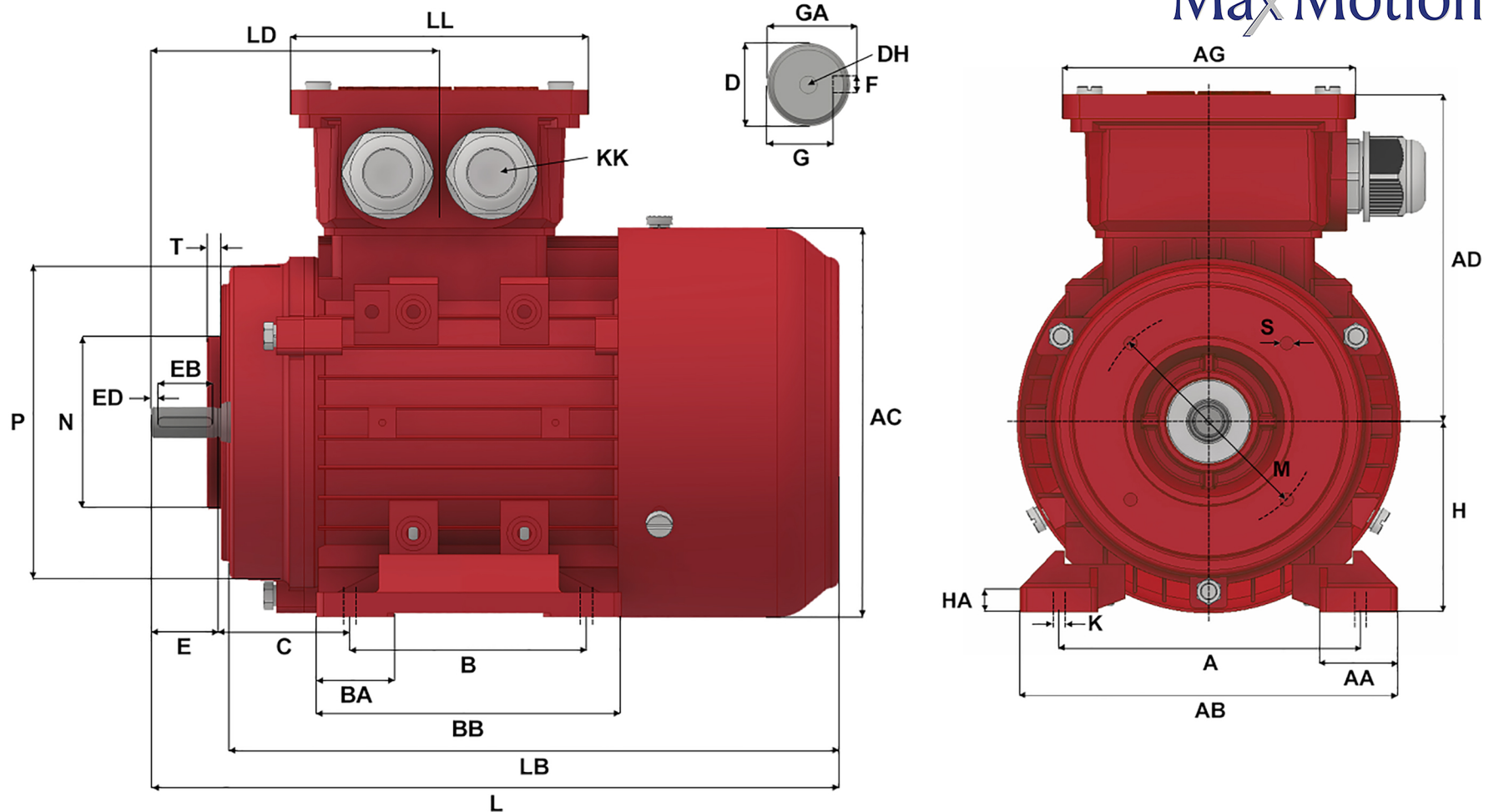

Version: 1JLEM				Revised: 09-11-2019				HP	RPM	FRAME	ENCLOSURE	IJA801-2-B34A		
Customer is responsible in determining that Max Motion product will fit/perform suitably in the intended application								1	3455	80	TEFC			
A	B	C	D	E	F	G	H	K	L	M	N	P		
125	100	50	19	40	6	15.5	80	10 X 14	300	100	80	120		
S	T	AA	AB	AC	AD	AG	BA	BB	DH	EB	ED	GA		
M6	3	35	157	158	135	101	31	125	M6 X 16	30	5	21.5		
HA	KK (1)	KK (2)	KK (3)	LB	LD	LL								
8	M20 X 1.5	1/2" NPT	-	260	115	101								